

GENERAL DESCRIPTION

Retrofit Kit has a beautiful design intended for outdoor wall mounted applications, combines the latest in LED technology including weathertight IP65 LED driver and thermal management. high-performance illumination that lasts 100,000HRS It's ideal for replacing 150-1000W Metal Halide, with typical energy savings of 80%.

APPLICATION

Outdoor Pole/Arm-mounted Area and Roadway Luminaires

PRODUCT SPECIFICATIONS

Part No	AL-WRK60W120V-50K	AL-WRK80W120V-50K	AL-WRK100W120V-50K	AL-WRK120W120V-50K	AL-WRK150W120V-50K
Meanwell Model	HVG-65-24A	CEN-100-24A	CLG-150-24A	CLG-150-24A	CLG-150-48A
LED QTY	72PCS	90PCS	111PCS	138PCS	175PCS
Input Power	60W	80W	100W	120W	150W
Color temperature	4000K-4500K,5000K-5700K				
Input Voltage	100-277VAC 50/60Hz				
Viewing Angle	120 Degree				
LED Brand	PHILIPS				
LED Type	3030, 1.5W				
Housing	Aluminum				
Housing color	Gray				

LIGHTING UP THE WORLD
WITH ONE BULB AT A TIME!

CONSTRUCTION AND MATERIALS

Aluminum heat sink behind led on the fixture, plastic module lens with over 90% light efficiency.

ELECTRIC CHARACTERISTIC

LPW: Lumen/Watt:	100-120lm/W
Working Environment Temperature: -20~+45°C	
Operating Humidity	20%-90% RH
Storage Temperature	10%-95%
CRI	>80
Safety Certification	UL、cUL
Warranty Time	5 Years

LUMEN OUTPUT

Power	Equivalent	Lumen
60W	450W incandescent / 150W CFL	6000-8100LM
80W	600 incandescent/180W CFL	8000-10800LM
100W	800 incandescent/250W CFL	10000-13500LM
120W	900 incandescent/300W CFL	12000-16200LM
150W	1200 incandescent/350W CFL	15000-20000LM

INSTALLATION MANUAL

Warning: Please make sure the power is off before installation.

1. Fix the U bracket on the installation bracket with screws, see Figure 1.
2. Fix the lamp body on the bracket with screws, see Figure 2.
3. Adjust the length, height, etc. of the lamp body and bracket as per your specific requirements. see Figure 3.
4. Take down all screw bases and ballasts in the fixtures before installation.
5. Fix the driver on the fixture of the lamp with screws, then fix the products with fixed bracket on the fixture.
6. Connect correctly the input wire of the lamp body and the output wire of the driver, see Figure 4.
7. If the lamps are installed vertically, take highbay fixtures for example, see Figure 5.
8. Connect the driver with local electric supply, insulation measures are needed when connecting the wires.
9. Turn on the power after the product is properly installed, then it can work normally.

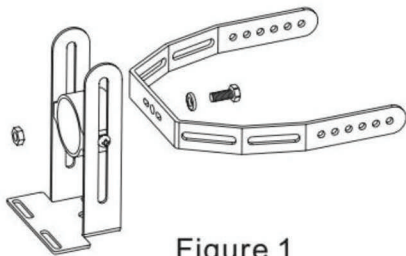

Figure 1

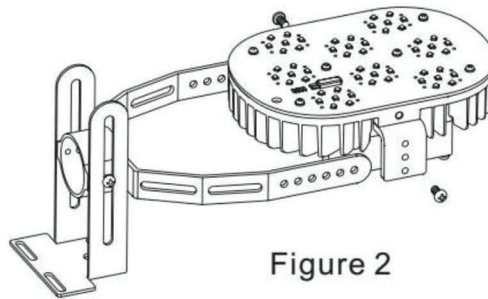

Figure 2

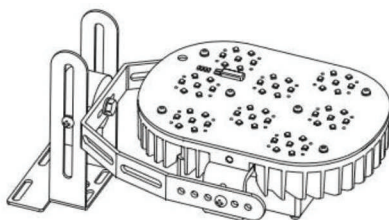

Figure 3

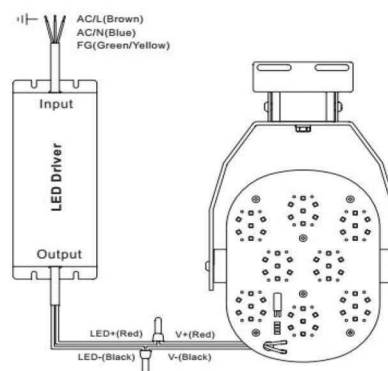

Figure 4

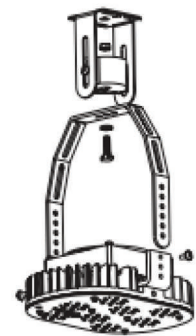

Figure 5

INSTALLATION MANUAL

Notice:

1. When there is only one group of red and black wire on the lamp body, just connect the only driver with it.
 2. When there are two groups of red and black wire on the lamp body, we equip the lamp with the same two drivers,
 3. When there are three groups of red and black wire on the lamp body, we equip the lamp with the same three drivers, please connect each driver with either one group of red and black wire.
- driver with either one group of red and black wire.

Warning:

LED chips should not be touched by hands or any other installation tools.

Please use the protective cover while installing the retrofit. Thanks very much for cooperation.

APPLICATION

Outdoor Pole/Arm-mounted Area and Roadway Luminaires

Retrofitting Parking lots, shoeboxes, streetlights, floodlights, wall packs, high bays, and canopies has just been made simple.



LIGHTING UP THE WORLD
WITH ONE BULB AT A TIME!

PACKAGE

Watt	Size	Qty/Carton	Weight/Carton
60W			
inner box	27*22*13 CM	1	2.0 kg
Outer box	56*45*29 CM	8	17 kg
80W			
inner box	29*25*13 CM	1	2.5 kg
Outer box	53*31*30 CM	4	11 kg
100W			
inner box	29*25*13 CM	1	2.85 kg
Outer box	53*31*30 CM	4	12.5 kg
120W			
inner box	29*25*13 CM	1	2.9 kg
Outer box	53*31*30 CM	4	12.6 kg
150W			
inner box	41*29*16 CM	1	4.5 kg
Outer box	65*42*31 CM	4	19 kg

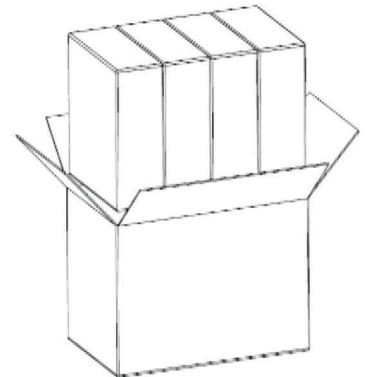
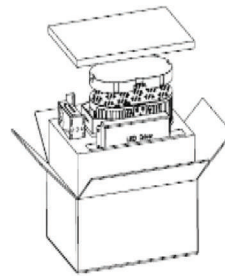
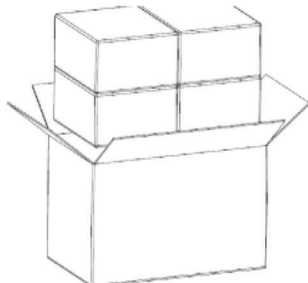
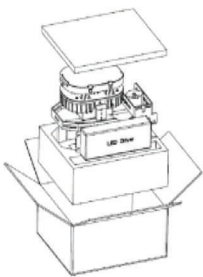

NOTICE FOR USER

Troubles

Flickering of the light
Out of working

Check points

Turn off the power and turn on again in 3 minutes. If same phenomena occur, then call agencies
Please check the connection

LIGHTING UP THE WORLD
WITH ONE BULB AT A TIME!